

# SN74LV123A-EP

## DUAL RETRIGGERABLE MONOSTABLE MULTIVIBRATOR WITH SCHMITT-TRIGGER INPUTS

SCLS498A – MAY 2003 – REVISED MAY 2004

- **Controlled Baseline**
  - One Assembly/Test Site, One Fabrication Site
- **Extended Temperature Performance of –40°C to 105°C**
- **Enhanced Diminishing Manufacturing Sources (DMS) Support**
- **Enhanced Product-Change Notification**
- **Qualification Pedigree†**
- **Typical  $V_{OLP}$  (Output Ground Bounce) <0.8 V at  $V_{CC} = 3.3$  V,  $T_A = 25^\circ\text{C}$**
- **Typical  $V_{OHV}$  (Output  $V_{OH}$  Undershoot) >2.3 V at  $V_{CC} = 3.3$  V,  $T_A = 25^\circ\text{C}$**
- **Supports Mixed-Mode Voltage Operation on All Ports**
- **Schmitt-Trigger Circuitry on  $\overline{A}$ , B, and  $\overline{CLR}$  Inputs for Slow Input Transition Rates**
- **Edge Triggered From Active-High or Active-Low Gated Logic Inputs**
- **$I_{off}$  Supports Partial-Power-Down Mode Operation**
- **Retriggerable for Very Long Output Pulses, Up To 100% Duty Cycle**
- **Overriding Clear Terminates Output Pulse**
- **Glitch-Free Power-Up Reset on Outputs**
- **ESD Protection Exceeds JESD 22**
  - 2000-V Human-Body Model (A114-A)
  - 200-V Machine Model (A115-A)
  - 1000-V Charged-Device Model (C101)

† Component qualification in accordance with JEDEC and industry standards to ensure reliable operation over an extended temperature range. This includes, but is not limited to, Highly Accelerated Stress Test (HAST) or biased 85/85, temperature cycle, autoclave or unbiased HAST, electromigration, bond intermetallic life, and mold compound life. Such qualification testing should not be viewed as justifying use of this component beyond specified performance and environmental limits.

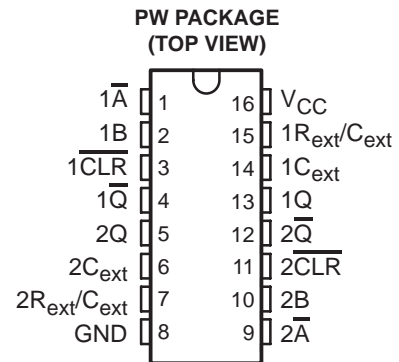

### description/ordering information

The SN74LV123A is a dual retriggerable monostable multivibrator designed for 2-V to 5.5-V  $V_{CC}$  operation.

This edge-triggered multivibrator features output pulse-duration control by three methods. In the first method, the  $\overline{A}$  input is low, and the B input goes high. In the second method, the B input is high, and the  $\overline{A}$  input goes low. In the third method, the  $\overline{A}$  input is low, the B input is high, and the clear ( $\overline{CLR}$ ) input goes high.

The output pulse duration is programmable by selecting external resistance and capacitance values. The external timing capacitor must be connected between  $C_{ext}$  and  $R_{ext}/C_{ext}$  (positive) and an external resistor connected between  $R_{ext}/C_{ext}$  and  $V_{CC}$ . To obtain variable pulse durations, connect an external variable resistance between  $R_{ext}/C_{ext}$  and  $V_{CC}$ . The output pulse duration also can be reduced by taking  $\overline{CLR}$  low.

Pulse triggering occurs at a particular voltage level and is not directly related to the transition time of the input pulse. The  $\overline{A}$ , B, and  $\overline{CLR}$  inputs have Schmitt triggers with sufficient hysteresis to handle slow input transition rates with jitter-free triggering at the outputs.

### ORDERING INFORMATION

$T_A$	PACKAGE‡		ORDERABLE PART NUMBER	TOP-SIDE MARKING
–40°C to 105°C	TSSOP – PW	Tape and reel	SN74LV123ATPWREP	L123AEP

‡ Package drawings, standard packing quantities, thermal data, symbolization, and PCB design guidelines are available at [www.ti.com/sc/package](http://www.ti.com/sc/package).



Please be aware that an important notice concerning availability, standard warranty, and use in critical applications of Texas Instruments semiconductor products and disclaimers thereto appears at the end of this data sheet.

PRODUCTION DATA information is current as of publication date. Products conform to specifications per the terms of Texas Instruments standard warranty. Production processing does not necessarily include testing of all parameters.

**TEXAS  
INSTRUMENTS**

POST OFFICE BOX 655303 • DALLAS, TEXAS 75265

Copyright © 2004, Texas Instruments Incorporated

# SN74LV123A-EP

## DUAL RETRIGGERABLE MONOSTABLE MULTIVIBRATOR WITH SCHMITT-TRIGGER INPUTS

SCLS498A – MAY 2003 – REVISED MAY 2004

### description/ordering information (continued)

Once triggered, the basic pulse duration can be extended by retriggering the gated low-level-active ( $\bar{A}$ ) or high-level-active (B) input. Pulse duration can be reduced by taking  $\overline{\text{CLR}}$  low. The input/output timing diagram illustrates pulse control by retriggering the inputs and early clearing.

During power up, Q outputs are in the low state, and  $\bar{Q}$  outputs are in the high state. The outputs are glitch free, without applying a reset pulse.

This device is fully specified for partial-power-down applications using  $I_{\text{off}}$ . The  $I_{\text{off}}$  circuitry disables the outputs, preventing damaging current backflow through the device when it is powered down.

**FUNCTION TABLE**  
(each multivibrator)

INPUTS			OUTPUTS	
$\overline{\text{CLR}}$	$\bar{A}$	B	Q	$\bar{Q}$
L	X	X	L	H
X	H	X	L†	H†
X	X	L	L†	H†
H	L	↑	⌋	⌋
H	↓	H	⌋	⌋
↑	L	H	⌋	⌋

† These outputs are based on the assumption that the indicated steady-state conditions at the A and B inputs have been set up long enough to complete any pulse started before the setup.

### logic diagram, each multivibrator (positive logic)

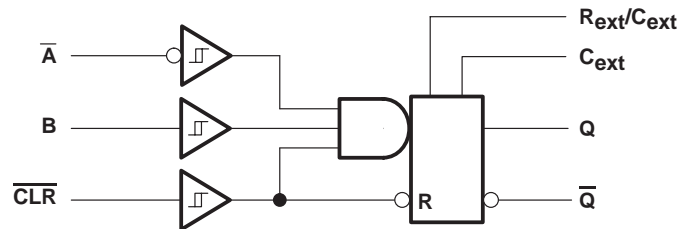

# SN74LV123A-EP

## DUAL RETRIGGERABLE MONOSTABLE MULTIVIBRATOR WITH SCHMITT-TRIGGER INPUTS

SCLS498A – MAY 2003 – REVISED MAY 2004

### input/output timing diagram

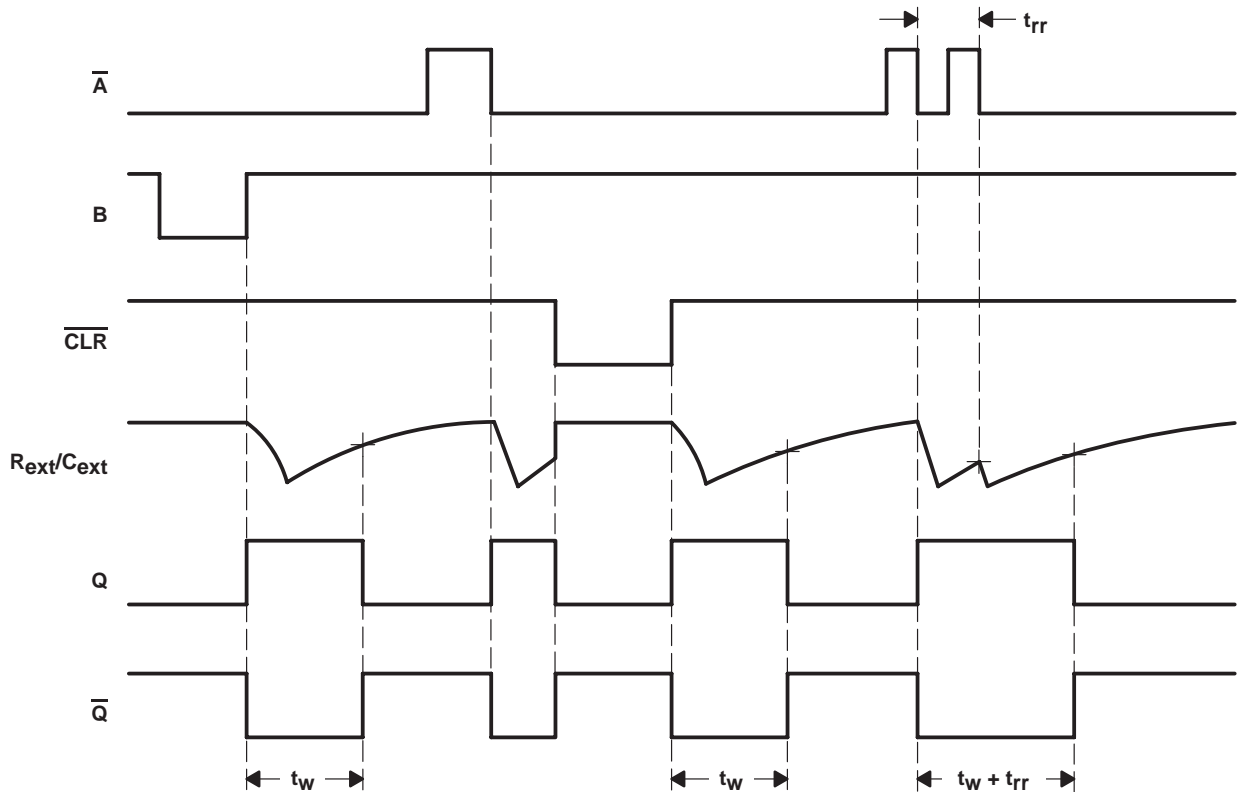

### absolute maximum ratings over operating free-air temperature (unless otherwise noted)†

Supply voltage range, $V_{CC}$ .....	-0.5 V to 7 V
Input voltage range, $V_I$ (see Note 1) .....	-0.5 V to 7 V
Voltage range applied to any output in the high-impedance or power-off state, $V_O$ (see Note 1) .....	-0.5 V to 7 V
Output voltage range in high or low state, $V_O$ (see Notes 1 and 2) .....	-0.5 V to $V_{CC} + 0.5$ V
Output voltage range in power-off state, $V_O$ (see Note 1) .....	-0.5 V to 7 V
Input clamp current, $I_{IK}$ ( $V_I < 0$ ) .....	-20 mA
Output clamp current, $I_{OK}$ ( $V_O < 0$ ) .....	-50 mA
Continuous output current, $I_O$ ( $V_O = 0$ to $V_{CC}$ ) .....	$\pm 25$ mA
Continuous current through $V_{CC}$ or GND .....	$\pm 50$ mA
Package thermal impedance, $\theta_{JA}$ (see Note 3) .....	113°C/W
Storage temperature range, $T_{stg}$ .....	-65°C to 150°C

† Stresses beyond those listed under “absolute maximum ratings” may cause permanent damage to the device. These are stress ratings only, and functional operation of the device at these or any other conditions beyond those indicated under “recommended operating conditions” is not implied. Exposure to absolute-maximum-rated conditions for extended periods may affect device reliability.

- NOTES: 1. The input and output negative-voltage ratings may be exceeded if the input and output current ratings are observed.  
 2. This value is limited to 5.5 V maximum.  
 3. The package thermal impedance is calculated in accordance with JESD 51-7.

# SN74LV123A-EP

## DUAL RETRIGGERABLE MONOSTABLE MULTIVIBRATOR WITH SCHMITT-TRIGGER INPUTS

SCLS498A – MAY 2003 – REVISED MAY 2004

### recommended operating conditions (see Note 4)

		MIN	MAX	UNIT
$V_{CC}$	Supply voltage	2	5.5	V
$V_{IH}$	High-level input voltage	$V_{CC} = 2\text{ V}$	1.5	V
		$V_{CC} = 2.3\text{ V to }2.7\text{ V}$	$V_{CC} \times 0.7$	
		$V_{CC} = 3\text{ V to }3.6\text{ V}$	$V_{CC} \times 0.7$	
		$V_{CC} = 4.5\text{ V to }5.5\text{ V}$	$V_{CC} \times 0.7$	
$V_{IL}$	Low-level input voltage	$V_{CC} = 2\text{ V}$	0.5	V
		$V_{CC} = 2.3\text{ V to }2.7\text{ V}$	$V_{CC} \times 0.3$	
		$V_{CC} = 3\text{ V to }3.6\text{ V}$	$V_{CC} \times 0.3$	
		$V_{CC} = 4.5\text{ V to }5.5\text{ V}$	$V_{CC} \times 0.3$	
$V_I$	Input voltage	0	5.5	V
$V_O$	Output voltage	0	$V_{CC}$	V
$I_{OH}$	High-level output current	$V_{CC} = 2\text{ V}$	-50	mA
		$V_{CC} = 2.3\text{ V to }2.7\text{ V}$	-2	
		$V_{CC} = 3\text{ V to }3.6\text{ V}$	-6	
		$V_{CC} = 4.5\text{ V to }5.5\text{ V}$	-12	
$I_{OL}$	Low-level output current	$V_{CC} = 2\text{ V}$	50	mA
		$V_{CC} = 2.3\text{ V to }2.7\text{ V}$	2	
		$V_{CC} = 3\text{ V to }3.6\text{ V}$	6	
		$V_{CC} = 4.5\text{ V to }5.5\text{ V}$	12	
$R_{ext}$	External timing resistance	$V_{CC} = 2\text{ V}$	5k	$\Omega$
		$V_{CC} \geq 3\text{ V}$	1k	
$C_{ext}$	External timing capacitance	No restriction		pF
$\Delta t/\Delta V_{CC}$	Power-up ramp rate	1		ms/V
$T_A$	Operating free-air temperature	-40	105	$^{\circ}\text{C}$

NOTE 4: All unused inputs of the device must be held at  $V_{CC}$  or GND to ensure proper device operation. Refer to the TI application report, *Implications of Slow or Floating CMOS Inputs*, literature number SCBA004.



# SN74LV123A-EP

## DUAL RETRIGGERABLE MONOSTABLE MULTIVIBRATOR WITH SCHMITT-TRIGGER INPUTS

SCLS498A – MAY 2003 – REVISED MAY 2004

electrical characteristics over recommended operating free-air temperature range (unless otherwise noted)

PARAMETER		TEST CONDITIONS	V <sub>CC</sub>	MIN	TYP	MAX	UNIT
V <sub>OH</sub>		I <sub>OH</sub> = -50 μA	2 V to 5.5 V	V <sub>CC</sub> -0.1			V
		I <sub>OH</sub> = -2 mA	2.3 V	2			
		I <sub>OH</sub> = -6 mA	3 V	2.48			
		I <sub>OH</sub> = -12 mA	4.5 V	3.8			
V <sub>OL</sub>		I <sub>OL</sub> = 50 μA	2 V to 5.5 V	0.1			V
		I <sub>OL</sub> = 2 mA	2.3 V	0.4			
		I <sub>OL</sub> = 6 mA	3 V	0.44			
		I <sub>OL</sub> = 12 mA	4.5 V	0.55			
I <sub>I</sub>	R <sub>ext</sub> /C <sub>ext</sub> <sup>†</sup>	V <sub>I</sub> = 5.5 V or GND	2 V to 5.5 V	±2.5			μA
	$\overline{A}$ , B, and $\overline{CLR}$	V <sub>I</sub> = 5.5 V or GND	0 0 to 5.5 V	±1 ±1			
I <sub>CC</sub>	Quiescent	V <sub>I</sub> = V <sub>CC</sub> or GND, I <sub>O</sub> = 0	5.5 V	20			μA
I <sub>CC</sub>	Active state (per circuit)	V <sub>I</sub> = V <sub>CC</sub> or GND, R <sub>ext</sub> /C <sub>ext</sub> = 0.5 V <sub>CC</sub>	3 V	280			μA
			4.5 V	650			
			5.5 V	975			
I <sub>off</sub>		V <sub>I</sub> or V <sub>O</sub> = 0 to 5.5 V	0	5			μA
C <sub>i</sub>		V <sub>I</sub> = V <sub>CC</sub> or GND	3.3 V	1.9			pF
			5 V	1.9			

<sup>†</sup> This test is performed with the terminal in the off-state condition.

timing requirements over recommended operating free-air temperature range, V<sub>CC</sub> = 3.3 V ± 0.3 V (unless otherwise noted) (see Figure 1)

		TEST CONDITIONS		T <sub>A</sub> = 25°C			MIN	MAX	UNIT
				MIN	TYP	MAX			
t <sub>w</sub>	Pulse duration	$\overline{CLR}$		5			5		ns
		$\overline{A}$ or B trigger		5			5		
t <sub>rr</sub>	Pulse retrigger time	R <sub>ext</sub> = 1 kΩ	C <sub>ext</sub> = 100 pF	‡	76		‡		ns
			C <sub>ext</sub> = 0.01 μF	‡	1.8		‡		μs

<sup>‡</sup> See retriggering data in the *application information* section.

timing requirements over recommended operating free-air temperature range, V<sub>CC</sub> = 5 V ± 0.5 V (unless otherwise noted) (see Figure 1)

		TEST CONDITIONS		T <sub>A</sub> = 25°C			MIN	MAX	UNIT
				MIN	TYP	MAX			
t <sub>w</sub>	Pulse duration	$\overline{CLR}$		5			5		ns
		$\overline{A}$ or B trigger		5			5		
t <sub>rr</sub>	Pulse retrigger time	R <sub>ext</sub> = 1 kΩ	C <sub>ext</sub> = 100 pF	‡	59		‡		ns
			C <sub>ext</sub> = 0.01 μF	‡	1.5		‡		μs

<sup>‡</sup> See retriggering data in the *application information* section.



# SN74LV123A-EP

## DUAL RETRIGGERABLE MONOSTABLE MULTIVIBRATOR WITH SCHMITT-TRIGGER INPUTS

SCLS498A – MAY 2003 – REVISED MAY 2004

switching characteristics over recommended operating free-air temperature range,  $V_{CC} = 3.3\text{ V} \pm 0.3\text{ V}$  (unless otherwise noted) (see Figure 1)

PARAMETER	FROM (INPUT)	TO (OUTPUT)	TEST CONDITIONS	$T_A = 25^\circ\text{C}$			MIN	MAX	UNIT
				MIN	TYP	MAX			
$t_{pd}$	$\bar{A}$ or B	Q or $\bar{Q}$	$C_L = 50\text{ pF}$	11.8	24.1		1	27.5	ns
	$\overline{\text{CLR}}$	Q or $\bar{Q}$		10.5	19.3		1	22	
	$\overline{\text{CLR}}$ trigger	Q or $\bar{Q}$		12.3	25.9		1	29.5	
$t_w^\dagger$		Q or $\bar{Q}$	$C_L = 50\text{ pF}$ , $C_{ext} = 28\text{ pF}$ , $R_{ext} = 2\text{ k}\Omega$	182	240			300	ns
			$C_L = 50\text{ pF}$ , $C_{ext} = 0.01\text{ }\mu\text{F}$ , $R_{ext} = 10\text{ k}\Omega$	90	100	110	90	110	$\mu\text{s}$
			$C_L = 50\text{ pF}$ , $C_{ext} = 0.1\text{ }\mu\text{F}$ , $R_{ext} = 10\text{ k}\Omega$	0.9	1	1.1	0.9	1.1	ms
$\Delta t_w^\ddagger$			$C_L = 50\text{ pF}$	$\pm 1$					%

$^\dagger t_w$  = Duration of pulse at Q and  $\bar{Q}$  outputs

$^\ddagger \Delta t_w$  = Output pulse-duration variation (Q and  $\bar{Q}$ ) between circuits in same package

switching characteristics over recommended operating free-air temperature range,  $V_{CC} = 5\text{ V} \pm 0.5\text{ V}$  (unless otherwise noted) (see Figure 1)

PARAMETER	FROM (INPUT)	TO (OUTPUT)	TEST CONDITIONS	$T_A = 25^\circ\text{C}$			MIN	MAX	UNIT
				MIN	TYP	MAX			
$t_{pd}$	$\bar{A}$ or B	Q or $\bar{Q}$	$C_L = 50\text{ pF}$	8.3	14		1	16	ns
	$\overline{\text{CLR}}$	Q or $\bar{Q}$		7.4	11.4		1	13	
	$\overline{\text{CLR}}$ trigger	Q or $\bar{Q}$		8.7	14.9		1	17	
$t_w^\dagger$		Q or $\bar{Q}$	$C_L = 50\text{ pF}$ , $C_{ext} = 28\text{ pF}$ , $R_{ext} = 2\text{ k}\Omega$	167	200			240	ns
			$C_L = 50\text{ pF}$ , $C_{ext} = 0.01\text{ }\mu\text{F}$ , $R_{ext} = 10\text{ k}\Omega$	90	100	110	90	110	$\mu\text{s}$
			$C_L = 50\text{ pF}$ , $C_{ext} = 0.1\text{ }\mu\text{F}$ , $R_{ext} = 10\text{ k}\Omega$	0.9	1	1.1	0.9	1.1	ms
$\Delta t_w^\ddagger$				$\pm 1$					%

$^\dagger t_w$  = Duration of pulse at Q and  $\bar{Q}$  outputs

$^\ddagger \Delta t_w$  = Output pulse-duration variation (Q and  $\bar{Q}$ ) between circuits in same package

operating characteristics,  $T_A = 25^\circ\text{C}$

PARAMETER	TEST CONDITIONS	$V_{CC}$	TYP	UNIT
$C_{pd}$ Power dissipation capacitance	$C_L = 50\text{ pF}$ , $f = 10\text{ MHz}$	3.3 V	44	pF
		5 V	49	



# SN74LV123A-EP DUAL RETRIGGERABLE MONOSTABLE MULTIVIBRATOR WITH SCHMITT-TRIGGER INPUTS

SCLS498A – MAY 2003 – REVISED MAY 2004

## PARAMETER MEASUREMENT INFORMATION

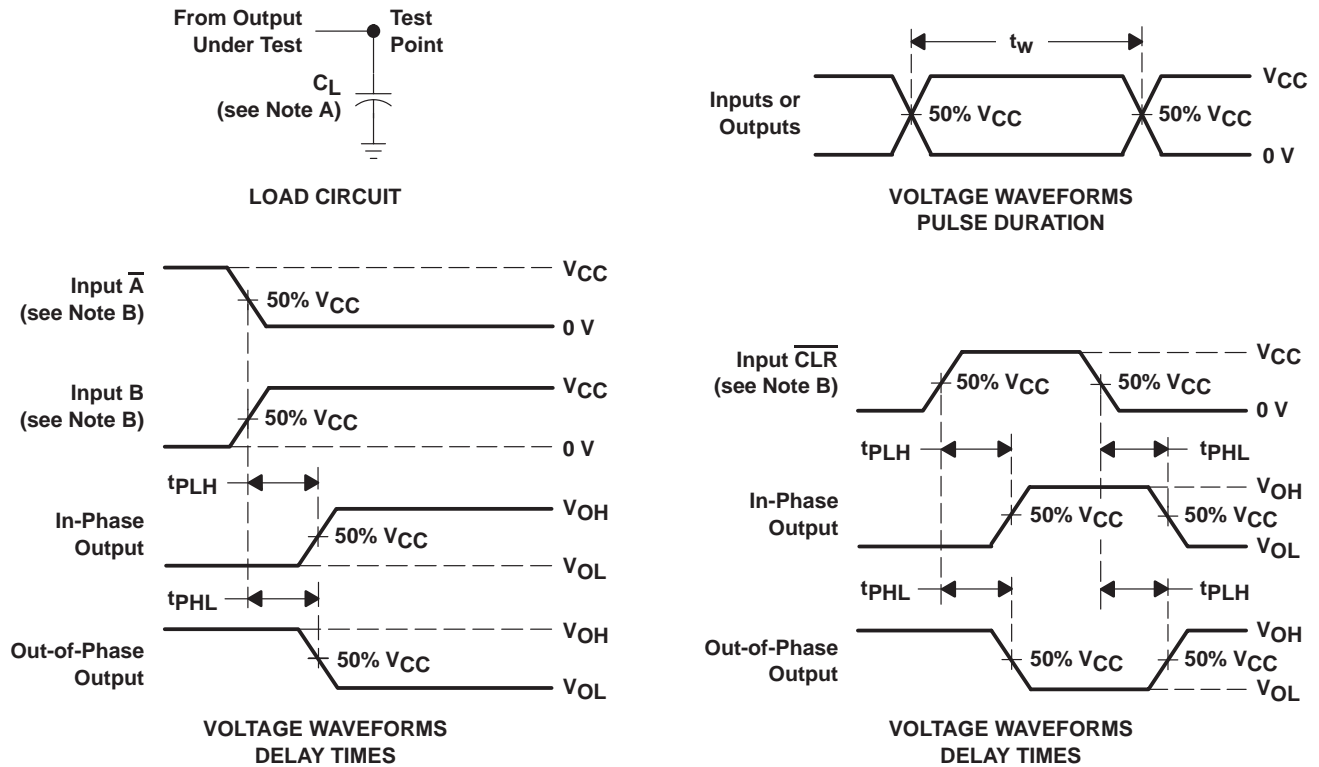

- NOTES: A.  $C_L$  includes probe and jig capacitance.  
 B. All input pulses are supplied by generators having the following characteristics: PRR  $\leq 1$  MHz,  $Z_O = 50 \Omega$ ,  $t_r = 3$  ns,  $t_f = 3$  ns.  
 C. The outputs are measured one at a time, with one input transition per measurement.

**Figure 1. Load Circuit and Voltage Waveforms**

# SN74LV123A-EP DUAL RETRIGGERABLE MONOSTABLE MULTIVIBRATOR WITH SCHMITT-TRIGGER INPUTS

SCLS498A – MAY 2003 – REVISED MAY 2004

## APPLICATION INFORMATION†

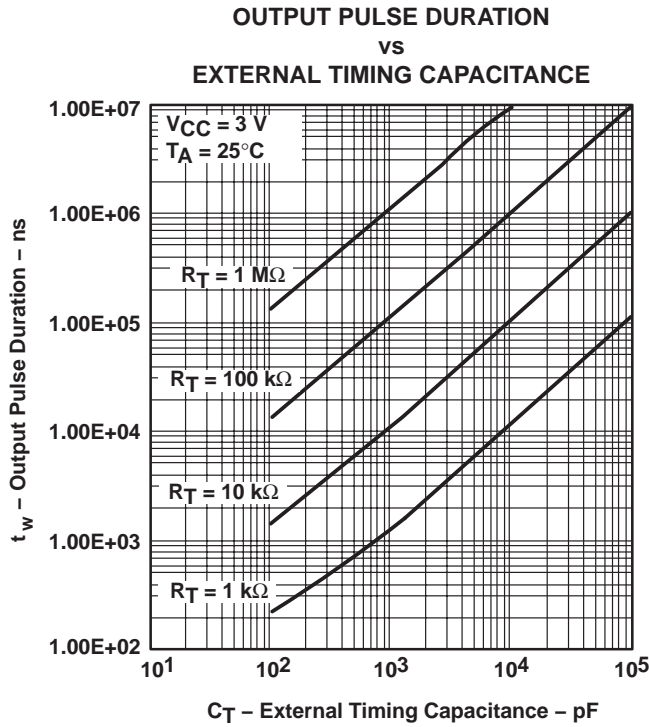

Figure 2

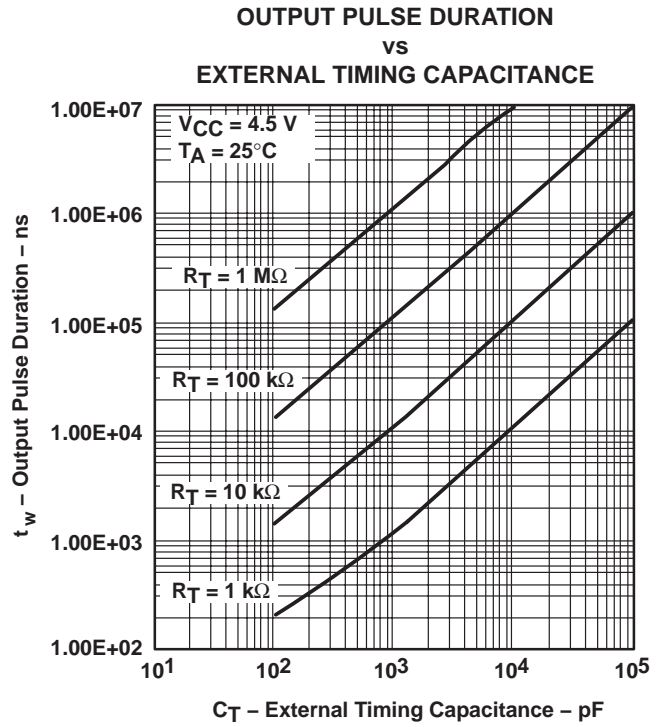

Figure 3

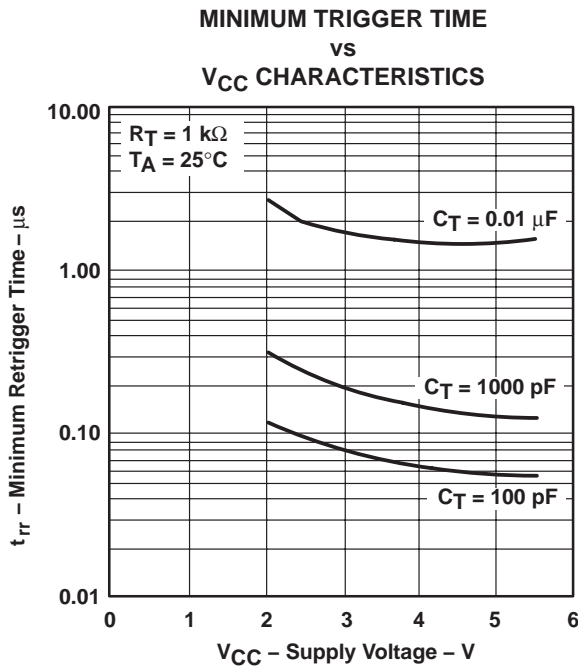

Figure 4

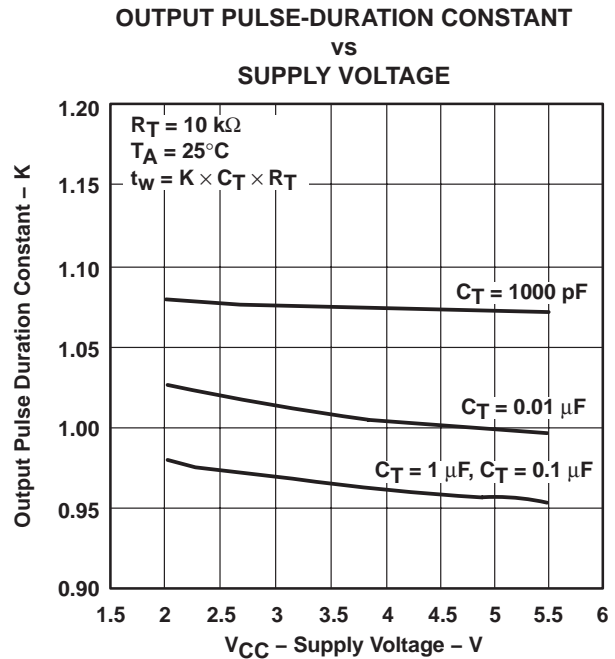

Figure 5

† Operation of the device at these or any other conditions beyond those indicated under "recommended operating conditions" is not implied.



**PACKAGING INFORMATION**

Orderable Device	Status <sup>(1)</sup>	Package Type	Package Drawing	Pins	Package Qty	Eco Plan <sup>(2)</sup>	Lead/Ball Finish	MSL Peak Temp <sup>(3)</sup>
SN74LV123ATPWREP	ACTIVE	TSSOP	PW	16	2000	Green (RoHS & no Sb/Br)	CU NIPDAU	Level-1-260C-UNLIM
V62/03661-01XE	ACTIVE	TSSOP	PW	16	2000	Green (RoHS & no Sb/Br)	CU NIPDAU	Level-1-260C-UNLIM

<sup>(1)</sup> The marketing status values are defined as follows:

**ACTIVE:** Product device recommended for new designs.

**LIFEBUY:** TI has announced that the device will be discontinued, and a lifetime-buy period is in effect.

**NRND:** Not recommended for new designs. Device is in production to support existing customers, but TI does not recommend using this part in a new design.

**PREVIEW:** Device has been announced but is not in production. Samples may or may not be available.

**OBsolete:** TI has discontinued the production of the device.

<sup>(2)</sup> Eco Plan - The planned eco-friendly classification: Pb-Free (RoHS), Pb-Free (RoHS Exempt), or Green (RoHS & no Sb/Br) - please check <http://www.ti.com/productcontent> for the latest availability information and additional product content details.

**TBD:** The Pb-Free/Green conversion plan has not been defined.

**Pb-Free (RoHS):** TI's terms "Lead-Free" or "Pb-Free" mean semiconductor products that are compatible with the current RoHS requirements for all 6 substances, including the requirement that lead not exceed 0.1% by weight in homogeneous materials. Where designed to be soldered at high temperatures, TI Pb-Free products are suitable for use in specified lead-free processes.

**Pb-Free (RoHS Exempt):** This component has a RoHS exemption for either 1) lead-based flip-chip solder bumps used between the die and package, or 2) lead-based die adhesive used between the die and leadframe. The component is otherwise considered Pb-Free (RoHS compatible) as defined above.

**Green (RoHS & no Sb/Br):** TI defines "Green" to mean Pb-Free (RoHS compatible), and free of Bromine (Br) and Antimony (Sb) based flame retardants (Br or Sb do not exceed 0.1% by weight in homogeneous material)

<sup>(3)</sup> MSL, Peak Temp. -- The Moisture Sensitivity Level rating according to the JEDEC industry standard classifications, and peak solder temperature.

**Important Information and Disclaimer:**The information provided on this page represents TI's knowledge and belief as of the date that it is provided. TI bases its knowledge and belief on information provided by third parties, and makes no representation or warranty as to the accuracy of such information. Efforts are underway to better integrate information from third parties. TI has taken and continues to take reasonable steps to provide representative and accurate information but may not have conducted destructive testing or chemical analysis on incoming materials and chemicals. TI and TI suppliers consider certain information to be proprietary, and thus CAS numbers and other limited information may not be available for release.

In no event shall TI's liability arising out of such information exceed the total purchase price of the TI part(s) at issue in this document sold by TI to Customer on an annual basis.

**OTHER QUALIFIED VERSIONS OF SN74LV123A-EP :**

- Catalog: [SN74LV123A](#)
- Automotive: [SN74LV123A-Q1](#)

NOTE: Qualified Version Definitions:

- Catalog - TI's standard catalog product
- Automotive - Q100 devices qualified for high-reliability automotive applications targeting zero defects

**TAPE AND REEL INFORMATION**



**QUADRANT ASSIGNMENTS FOR PIN 1 ORIENTATION IN TAPE**

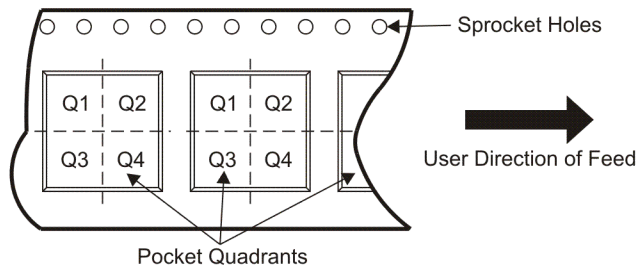

\*All dimensions are nominal

Device	Package Type	Package Drawing	Pins	SPQ	Reel Diameter (mm)	Reel Width W1 (mm)	A0 (mm)	B0 (mm)	K0 (mm)	P1 (mm)	W (mm)	Pin1 Quadrant
SN74LV123ATPWREP	TSSOP	PW	16	2000	330.0	12.4	7.0	5.6	1.6	8.0	12.0	Q1

**TAPE AND REEL BOX DIMENSIONS**



\*All dimensions are nominal

Device	Package Type	Package Drawing	Pins	SPQ	Length (mm)	Width (mm)	Height (mm)
SN74LV123ATPWREP	TSSOP	PW	16	2000	346.0	346.0	29.0

## IMPORTANT NOTICE

Texas Instruments Incorporated and its subsidiaries (TI) reserve the right to make corrections, modifications, enhancements, improvements, and other changes to its products and services at any time and to discontinue any product or service without notice. Customers should obtain the latest relevant information before placing orders and should verify that such information is current and complete. All products are sold subject to TI's terms and conditions of sale supplied at the time of order acknowledgment.

TI warrants performance of its hardware products to the specifications applicable at the time of sale in accordance with TI's standard warranty. Testing and other quality control techniques are used to the extent TI deems necessary to support this warranty. Except where mandated by government requirements, testing of all parameters of each product is not necessarily performed.

TI assumes no liability for applications assistance or customer product design. Customers are responsible for their products and applications using TI components. To minimize the risks associated with customer products and applications, customers should provide adequate design and operating safeguards.

TI does not warrant or represent that any license, either express or implied, is granted under any TI patent right, copyright, mask work right, or other TI intellectual property right relating to any combination, machine, or process in which TI products or services are used. Information published by TI regarding third-party products or services does not constitute a license from TI to use such products or services or a warranty or endorsement thereof. Use of such information may require a license from a third party under the patents or other intellectual property of the third party, or a license from TI under the patents or other intellectual property of TI.

Reproduction of TI information in TI data books or data sheets is permissible only if reproduction is without alteration and is accompanied by all associated warranties, conditions, limitations, and notices. Reproduction of this information with alteration is an unfair and deceptive business practice. TI is not responsible or liable for such altered documentation. Information of third parties may be subject to additional restrictions.

Resale of TI products or services with statements different from or beyond the parameters stated by TI for that product or service voids all express and any implied warranties for the associated TI product or service and is an unfair and deceptive business practice. TI is not responsible or liable for any such statements.

TI products are not authorized for use in safety-critical applications (such as life support) where a failure of the TI product would reasonably be expected to cause severe personal injury or death, unless officers of the parties have executed an agreement specifically governing such use. Buyers represent that they have all necessary expertise in the safety and regulatory ramifications of their applications, and acknowledge and agree that they are solely responsible for all legal, regulatory and safety-related requirements concerning their products and any use of TI products in such safety-critical applications, notwithstanding any applications-related information or support that may be provided by TI. Further, Buyers must fully indemnify TI and its representatives against any damages arising out of the use of TI products in such safety-critical applications.

TI products are neither designed nor intended for use in military/aerospace applications or environments unless the TI products are specifically designated by TI as military-grade or "enhanced plastic." Only products designated by TI as military-grade meet military specifications. Buyers acknowledge and agree that any such use of TI products which TI has not designated as military-grade is solely at the Buyer's risk, and that they are solely responsible for compliance with all legal and regulatory requirements in connection with such use.

TI products are neither designed nor intended for use in automotive applications or environments unless the specific TI products are designated by TI as compliant with ISO/TS 16949 requirements. Buyers acknowledge and agree that, if they use any non-designated products in automotive applications, TI will not be responsible for any failure to meet such requirements.

Following are URLs where you can obtain information on other Texas Instruments products and application solutions:

### Products

Amplifiers	<a href="http://amplifier.ti.com">amplifier.ti.com</a>
Data Converters	<a href="http://dataconverter.ti.com">dataconverter.ti.com</a>
DSP	<a href="http://dsp.ti.com">dsp.ti.com</a>
Clocks and Timers	<a href="http://www.ti.com/clocks">www.ti.com/clocks</a>
Interface	<a href="http://interface.ti.com">interface.ti.com</a>
Logic	<a href="http://logic.ti.com">logic.ti.com</a>
Power Mgmt	<a href="http://power.ti.com">power.ti.com</a>
Microcontrollers	<a href="http://microcontroller.ti.com">microcontroller.ti.com</a>
RFID	<a href="http://www.ti-rfid.com">www.ti-rfid.com</a>
RF/IF and ZigBee® Solutions	<a href="http://www.ti.com/lprf">www.ti.com/lprf</a>

### Applications

Audio	<a href="http://www.ti.com/audio">www.ti.com/audio</a>
Automotive	<a href="http://www.ti.com/automotive">www.ti.com/automotive</a>
Broadband	<a href="http://www.ti.com/broadband">www.ti.com/broadband</a>
Digital Control	<a href="http://www.ti.com/digitalcontrol">www.ti.com/digitalcontrol</a>
Medical	<a href="http://www.ti.com/medical">www.ti.com/medical</a>
Military	<a href="http://www.ti.com/military">www.ti.com/military</a>
Optical Networking	<a href="http://www.ti.com/opticalnetwork">www.ti.com/opticalnetwork</a>
Security	<a href="http://www.ti.com/security">www.ti.com/security</a>
Telephony	<a href="http://www.ti.com/telephony">www.ti.com/telephony</a>
Video & Imaging	<a href="http://www.ti.com/video">www.ti.com/video</a>
Wireless	<a href="http://www.ti.com/wireless">www.ti.com/wireless</a>

Mailing Address: Texas Instruments, Post Office Box 655303, Dallas, Texas 75265  
Copyright © 2008, Texas Instruments Incorporated